

NOTES:  
 1.MATERIAL:  
 1.1 HOUSING: SEE TABLE  
 1.2 CONTACTS: SEE TABLE  
 1.3 SHELL: SEE TABLE  
 1.4 COVER: SEE TABLE  
 2.FINISH:  
 2.1 CONTACT: SEE TABLE  
 2.2 SHELL: SEE TABLE  
 3.THE CONNECTOR IS ROHS COMPLIANT.  
 4.DATE CODE: X XXXXXX  
 YEAR  
 MONTH  
 DATE  
 5.SPEC PLS. REFER TO PS-50925-XXXX-XXX  
 6.PACKING REFER TO 55930-XXXX-XX-TRP  
 7.P/N: 55930-009 0 X - XXX  
 CKTS  
 PACKING:  
 0:TAPE&REEL  
 COLOR:  
 001: BLUE  
 PLATING:  
 2: GOLD FLASH ON CONTACT AREA

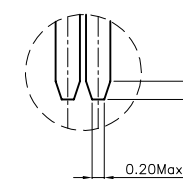

DETAIL: A  
SCALE 4: 1

Pin #	SIGNAL NAME
1	VBUS
2	D-
3	D+
4	GND
5	StdA_SSRX-
6	StdA_SSRX+
7	GND_DRAIN
8	StdA_SSTX-
9	StdA_SSTX+
Shell	Shield

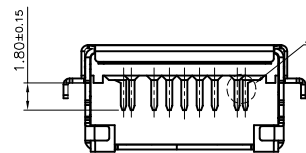
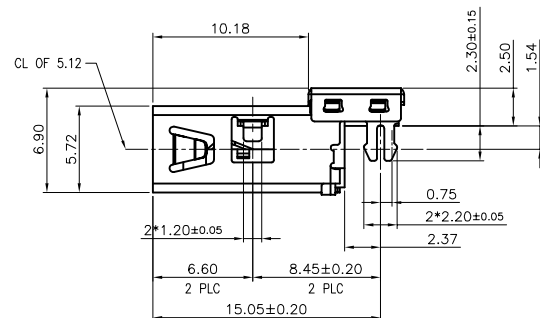
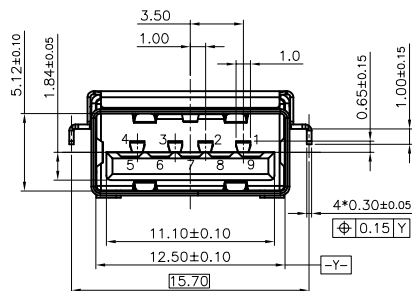
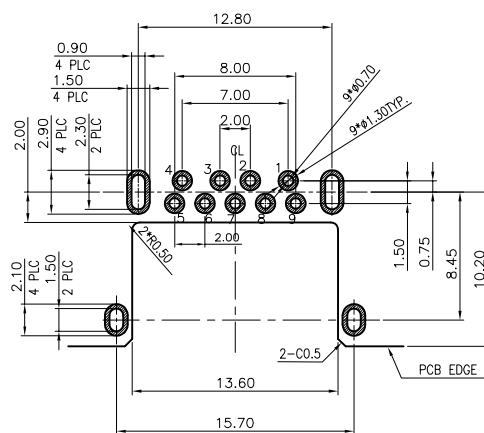
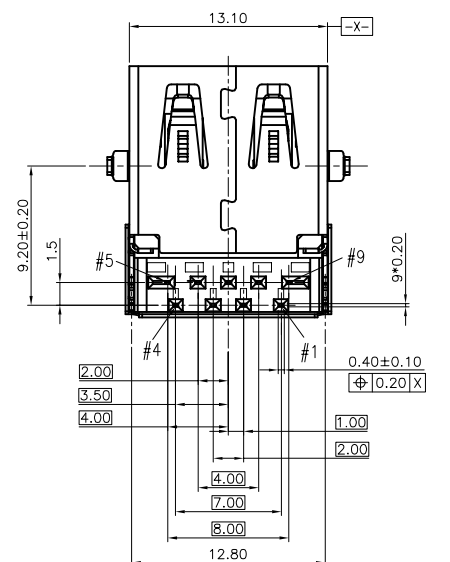

TOLERANCE: ±0.03, THICKNESS: 1.2mm  
 RECOMMENDED PCB LAYOUT  
 (TOP VIEW)  
 KEEP OUT AREA

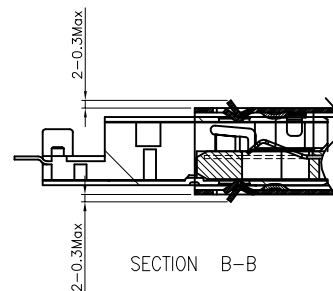

No.	Part Name	Q'TY	Material	Finish
1	HOUSING	1	PA9T	UL94 V-0
2	SHELL	1	SUS201	50μ" MIN. NICKEL PLATING
3	TERMINAL	9	C5210	50μ" MIN. Ni UNDER PLATED OVER ALL CONTACT AREA; REFER TO PART NUMBER SOLDER TAILS:100μ" MIN. MATTE TIN PLATED
4	COVER	1	SUS201	/

一般公差 <b>TOLERANCES</b> X ±0.5 .XX ±0.15 X ±0.25 .XXX ±0.1 ANGLES ±2°		<b>宏致電子股份有限公司</b> Aces Electronics Co.,Ltd.	
檢驗尺寸標示 <b>SYMBOLS</b> ⊕ ⊗ INDICATE CLASSIFICATION DIMENSION ⊕ MARK IS CRITICAL DIM. ⊗ MARK IS MAJOR DIM.		品名 (TITLE) USB3.0 REVERSE SINK A TYPE T/H R/A CH=-1.54mm 圖號 (DWG.NO) 55930-XXXXX-XXX	
表面處理 (FINISH)		製圖 (DR) ERIC '15/06/16 審核 (CHKD) AMY 核准 (APPD) FI	
比例 (SCALE) 單位 (UNITS) mm		張數 (SHEET) 1 OF 1 尺寸 (SIZE) A4 版次 (REV) A	